

# DIN 69893 HSK-A



Arbors

Grundaufnahmen

Державки

Stożki bazowe

Attacchi base

## HSK-A

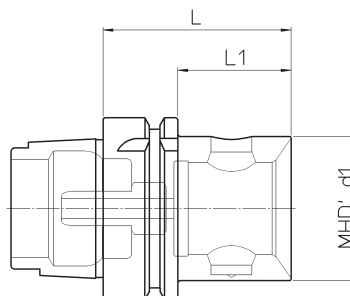
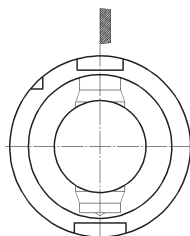

Supplied with coolant tube

Lieferung inklusive Kühlmittelrohr

Поставляются с каналом подвода СОЖ

Zawiera króciec do doprowadzenia chłodziwa

Completo di raccordo per il refrigerante

HSK-A	REF.	CODE	MHD' d <sub>1</sub>	L	L <sub>1</sub>	kg
40	HSK-A40 MHD'32.48	41 6 32 15 040 20	32	48	28	0.4
50	HSK-A50 MHD'50.66	41 6 50 15 050 20	50	66	—	0.6
63	HSK-A63 MHD'40.60	41 6 40 15 063 20	40	60	34	0.7
	HSK-A63 MHD'50.66	41 6 50 15 063 20	50	66	40	0.9
	HSK-A63 MHD'63.75	41 6 63 15 063 20	63	75	—	1.1
80	HSK-A80 MHD'50.70	41 6 50 15 080 20	50	70	44	1.5
	HSK-A80 MHD'63.80	41 6 63 15 080 20	63	80	54	1.8
	HSK-A80 MHD'80.86	41 6 80 15 080 20	80	86	—	2.1
100	HSK-A100 MHD'50.72	41 6 50 15 100 20	50	72	43	2.4
	HSK-A100 MHD'63.82	41 6 63 15 100 20	63	82	53	2.7
	HSK-A100 MHD'80.88	41 6 80 15 100 20	80	88	59	3

## HSK-A

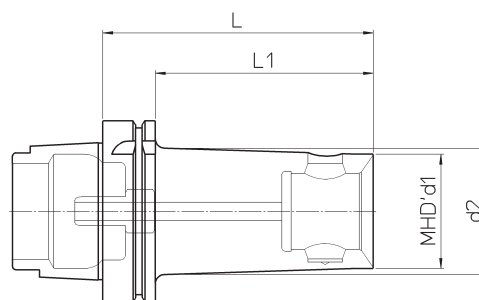
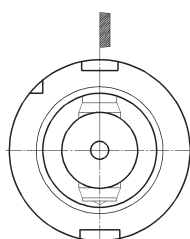

Supplied with coolant tube

Lieferung inklusive Kühlmittelrohr

Поставляются с каналом подвода СОЖ

Zawiera króciec do doprowadzenia chłodziwa

Completo di raccordo per il refrigerante

HSK-A	REF.	CODE	MHD' d <sub>1</sub>	d <sub>2</sub>	L	L <sub>1</sub>	kg
63	HSK-A63 MHD'40.120	41 6 40 15 063 28	40	46	120	94	1.4
	HSK-A63 MHD'50.120	41 6 50 15 063 28	50	—			1.7
100	HSK-A100 MHD'50.120	41 6 50 15 100 28	50	60	150	121	3.2
	HSK-A100 MHD'63.150	41 6 63 15 100 28	63	70			4.5
	HSK-A100 MHD'80.180	41 6 80 15 100 28	80	—			180

p. 229

p. 269

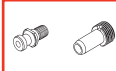

Arbors

Grundaufnahmen

Державки

Stożki bazowe

Attacchi base

**HSK-A  
F-MHD'**

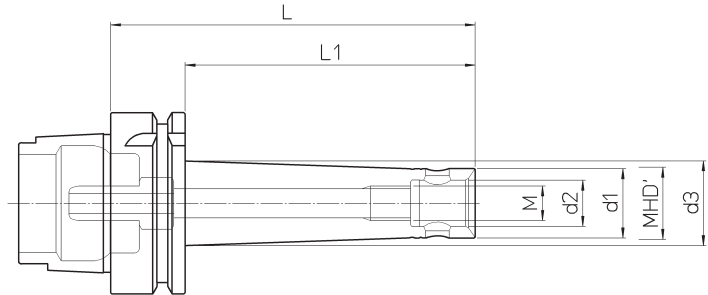

Supplied with coolant tube

Lieferung inklusive Kühlmittelrohr

Поставляются с каналомподвода СОЖ

Zawiera króciec do doprowadzenia chłodziwa

Completo di raccordo per il refrigerante

HSK-A	REF.	CODE	MHD'	d <sub>1</sub>	d <sub>2</sub>	d <sub>3</sub>	M	L	L <sub>1</sub>	kg
63	HSK-A63 F-MHD'16.63	41 6 16 06 563 20	16	15.5	10	17	M 8	63	37	0.7
	HSK-A63 F-MHD'16.100	41 6 16 10 563 20				19.5		100	74	0.8
	HSK-A63 F-MHD'20.63	41 6 20 06 563 20	20	19.5	13	-	M 10	63	37	0.6
	HSK-A63 F-MHD'20.90	41 6 20 09 563 20				22.5		90	64	0.8
	HSK-A63 F-MHD'20.125	41 6 20 12 563 20				25		125	99	0.9
	HSK-A63 F-MHD'25.63	41 6 25 06 563 20	25	24	16	-	M 12	63	37	0.7
	HSK-A63 F-MHD'25.90	41 6 25 09 563 20				27		90	64	0.9
	HSK-A63 F-MHD'25.125	41 6 25 12 563 20				29.5		125	99	1
	HSK-A63 F-MHD'32.90	41 6 32 09 563 20	32	31	20	33.5	M 16	90	64	1
	HSK-A63 F-MHD'32.125	41 6 32 12 563 20				36		125	99	1.2

62

p.269

p.229

UNI  
HSK DIN  
MAS-BT

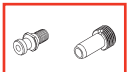

# DIN 69893 HSK



Arbors

Grundaufnahmen

Державки

Stożki bazowe

Attacchi base

## HSK-E

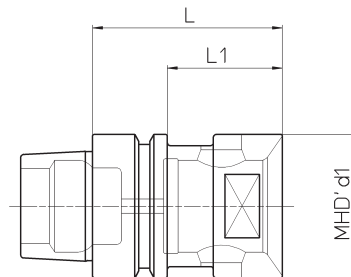
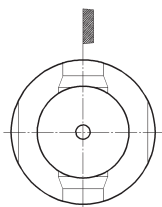

HSK-E	REF.	CODE	MHD' d <sub>1</sub>	L	L <sub>1</sub>	kg
40	HSK-E40 MHD'32.42	41 6 32 15 040 25	32	42	22	0.5
50	HSK-E50 MHD'50.66	41 6 50 15 050 25	50	66	—	0.6
63	HSK-E63 MHD'50.66	41 6 50 15 063 25			40	0.9

63

## HSK-F

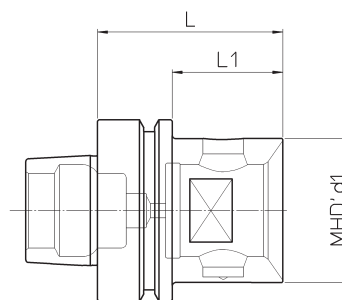
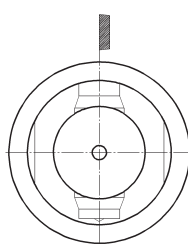

HSK-F	REF.	CODE	MHD' d <sub>1</sub>	L	L <sub>1</sub>	kg
63	HSK-F63 MHD'50.65	41 6 50 15 063 26	50	65	39	0.8